

Championnat de Belgique Flemalle 2018

Vendredi 28 septembre dressage

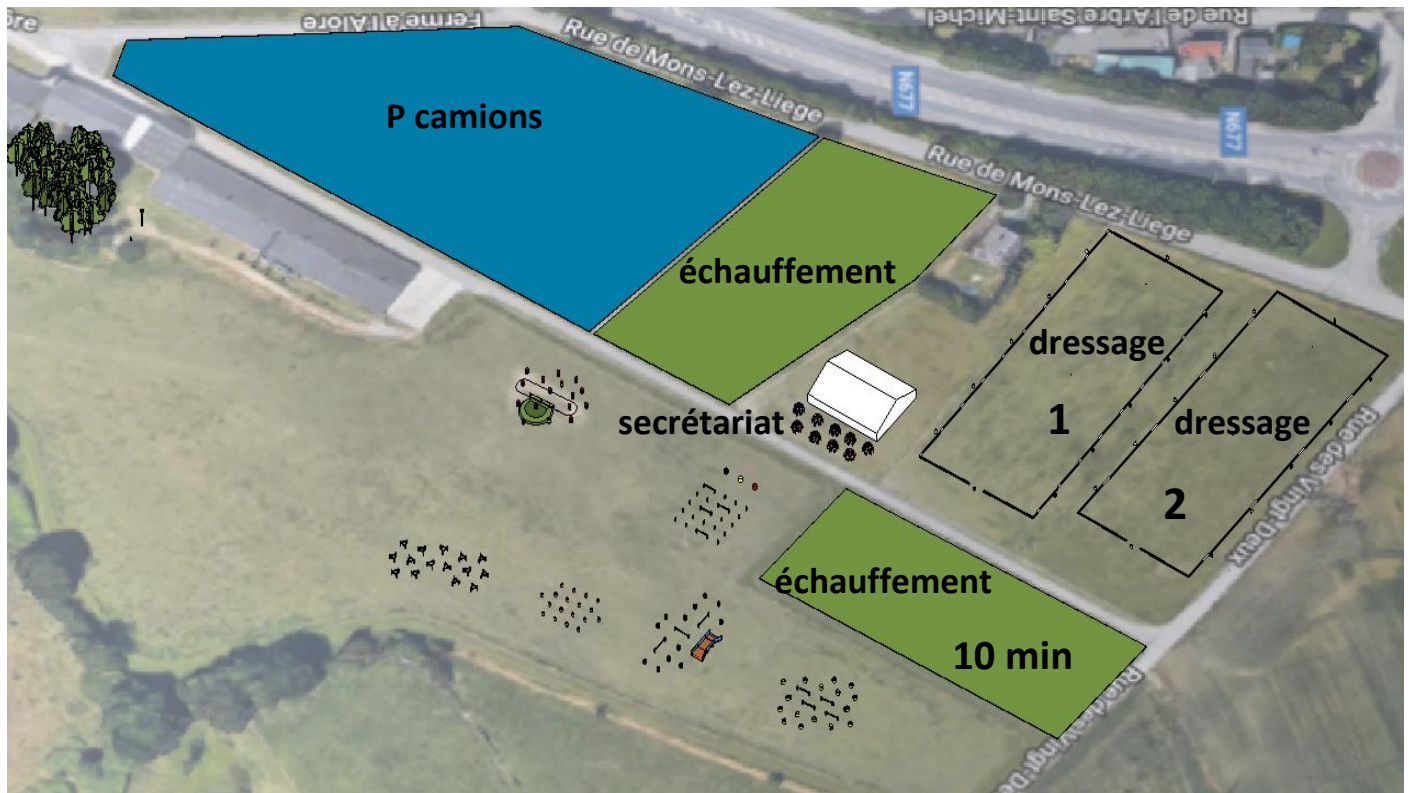

Samedi 29 septembre marathon

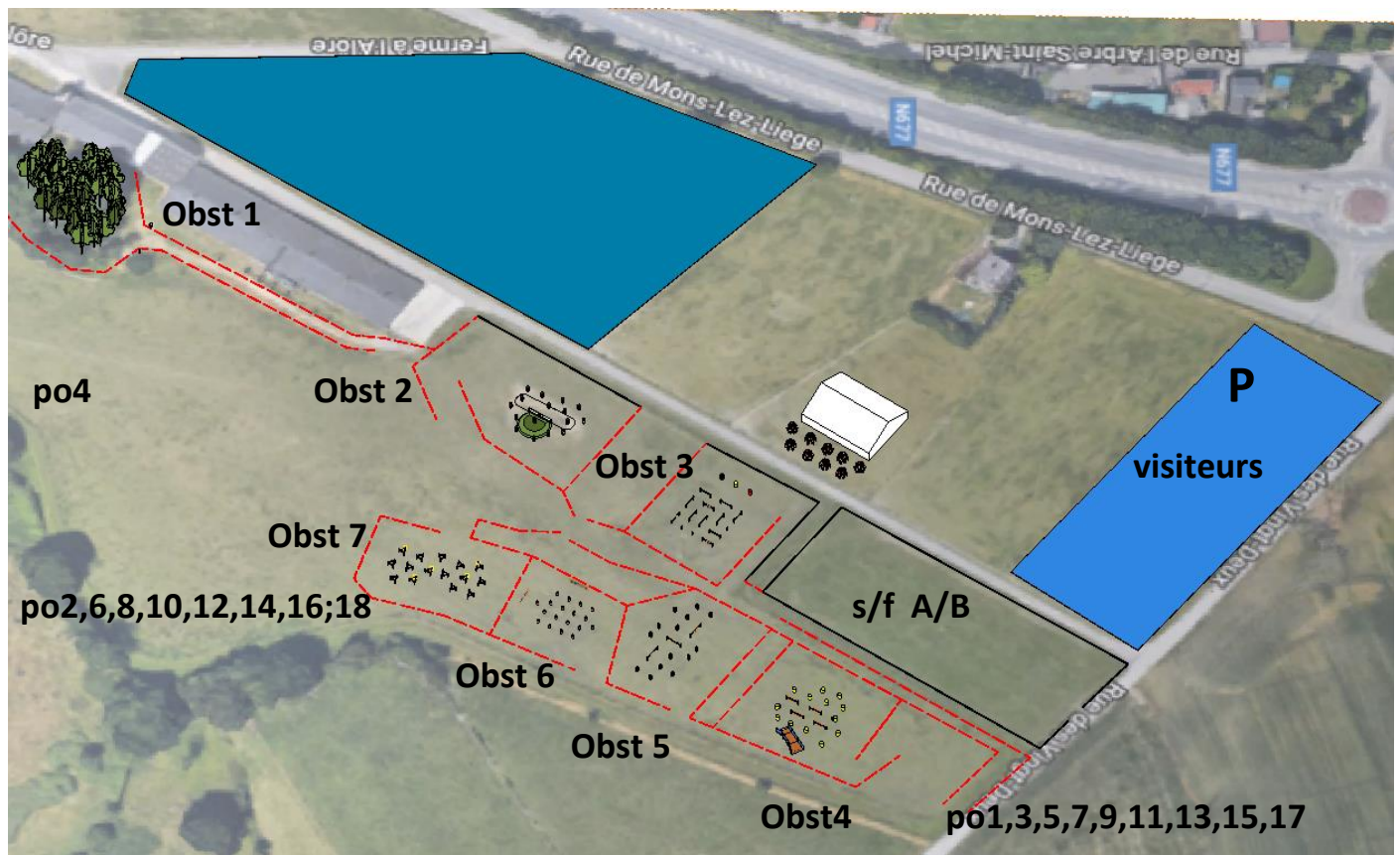

Obstacle 1 les arbres

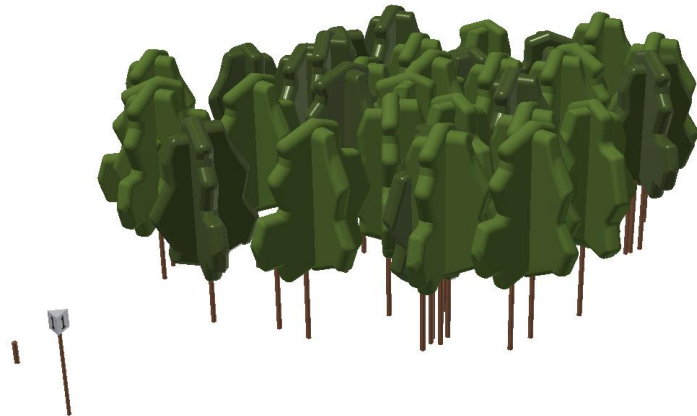

★ 0 X knock down

CAN*** A>F

CAN* XXX
(passer)

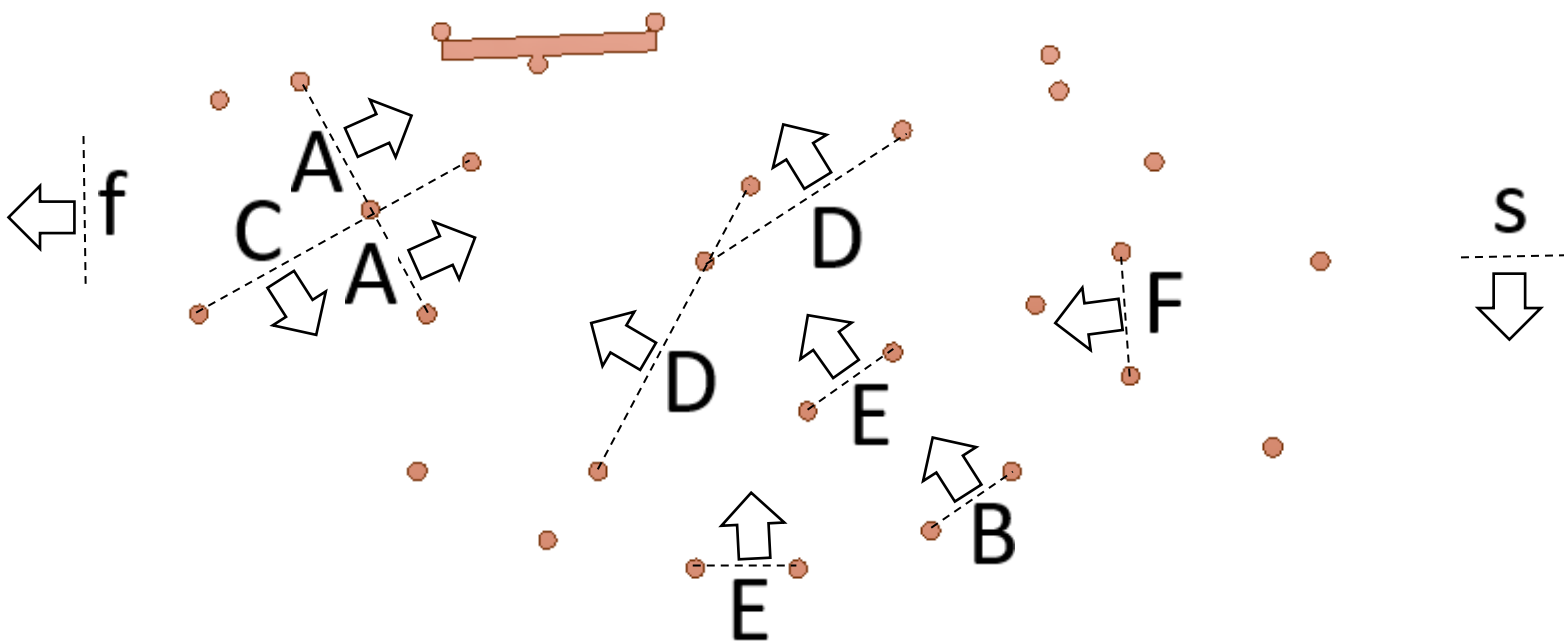

Obstacle 2 l'eau

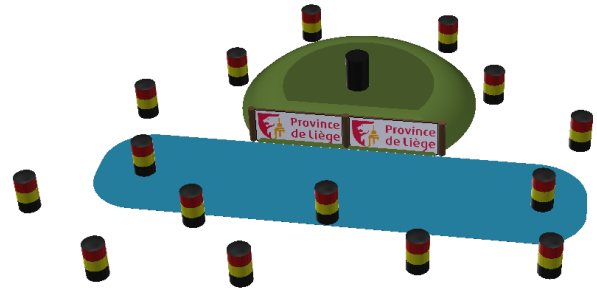

★ 2 X knock down

CAN*** A>F

CAN* A>E

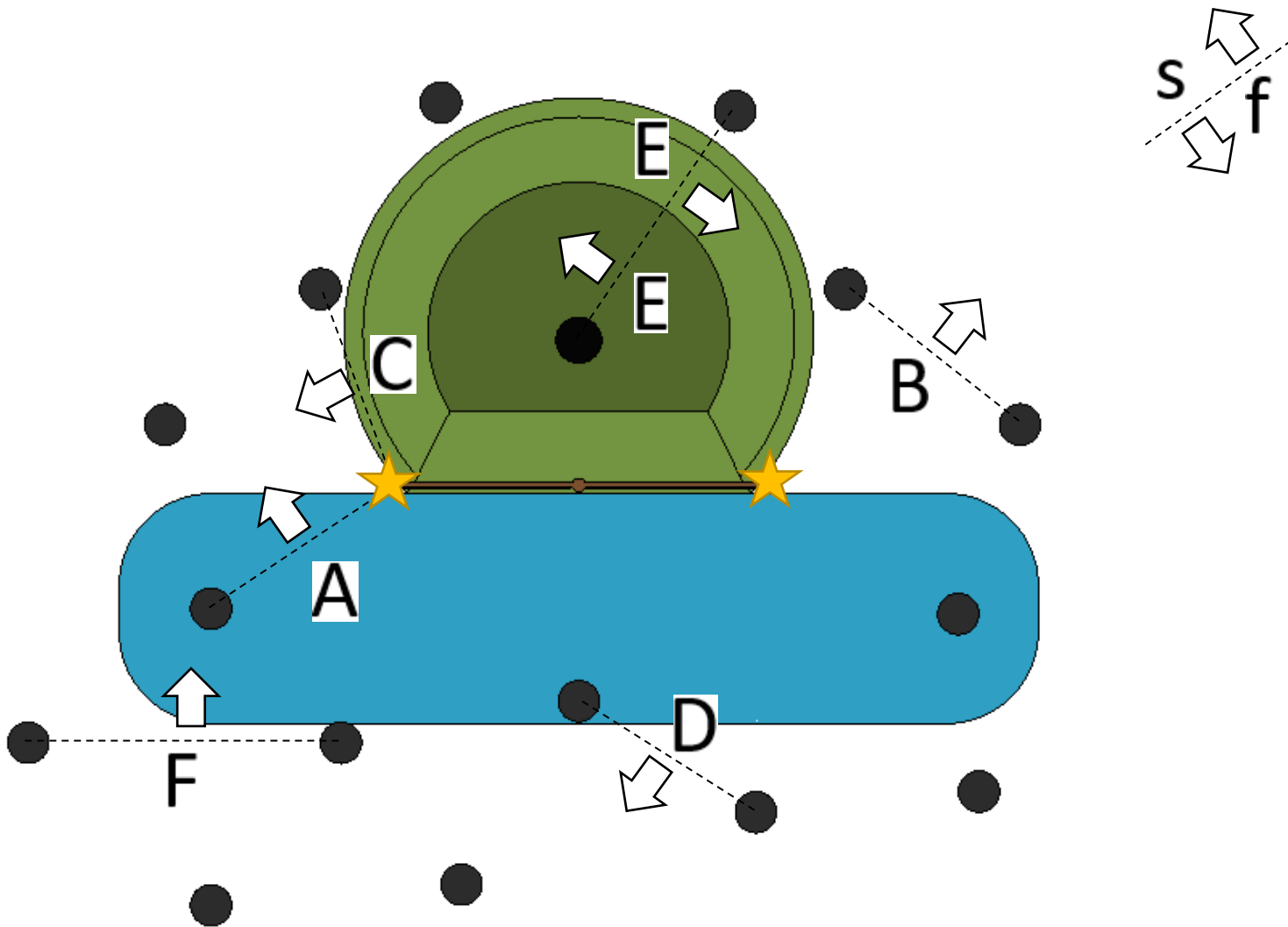

Obstacle 3 le carré

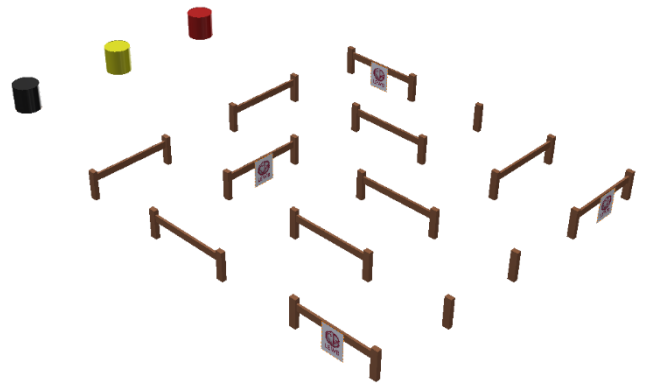

★ 3 X knock down

CAN*** A>F

CAN* A>E

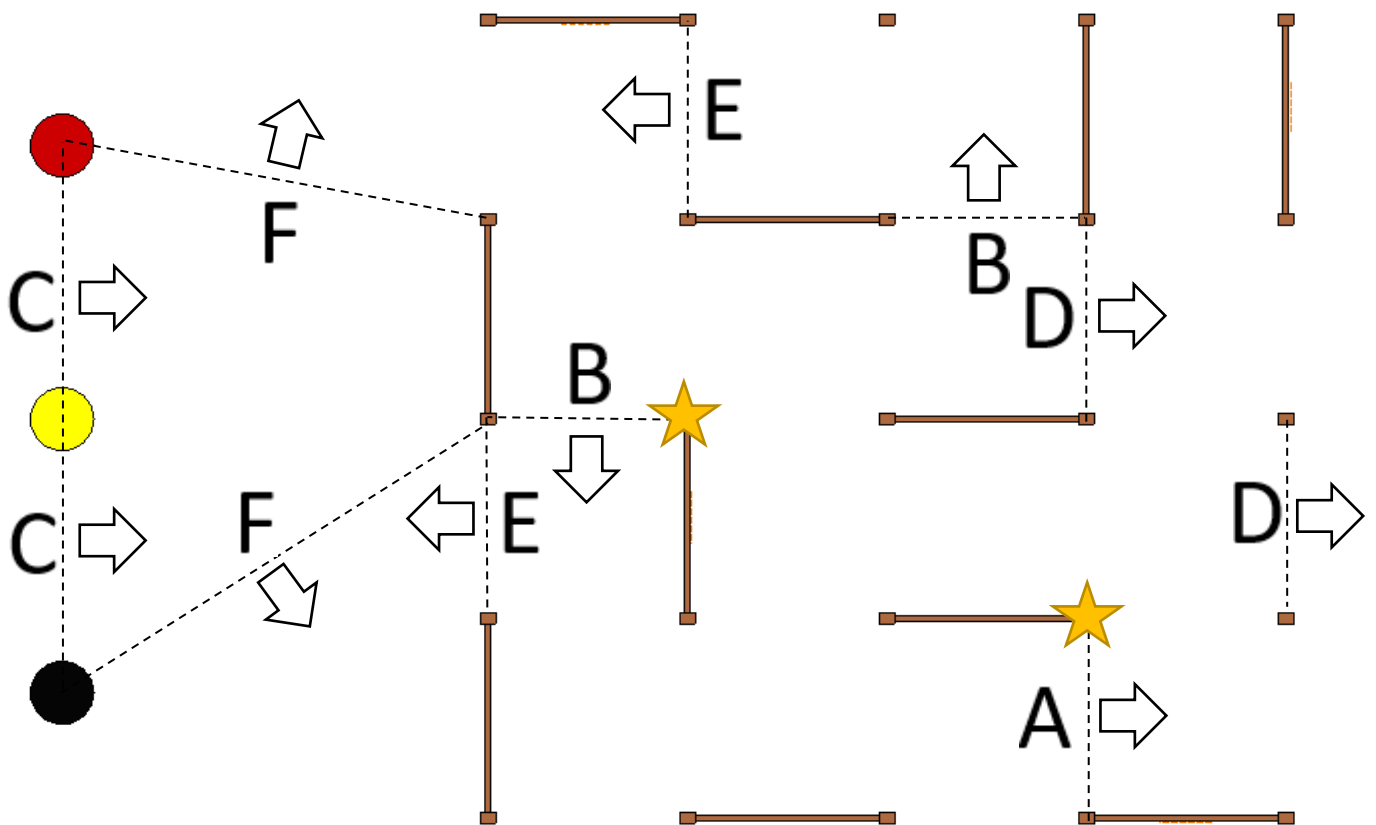
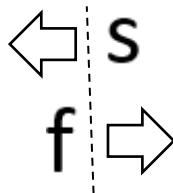

Obstacle 4 le pont

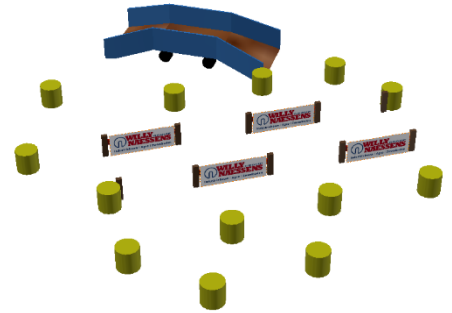

★ 1 X knock down

CAN*** A>F

CAN* A>E

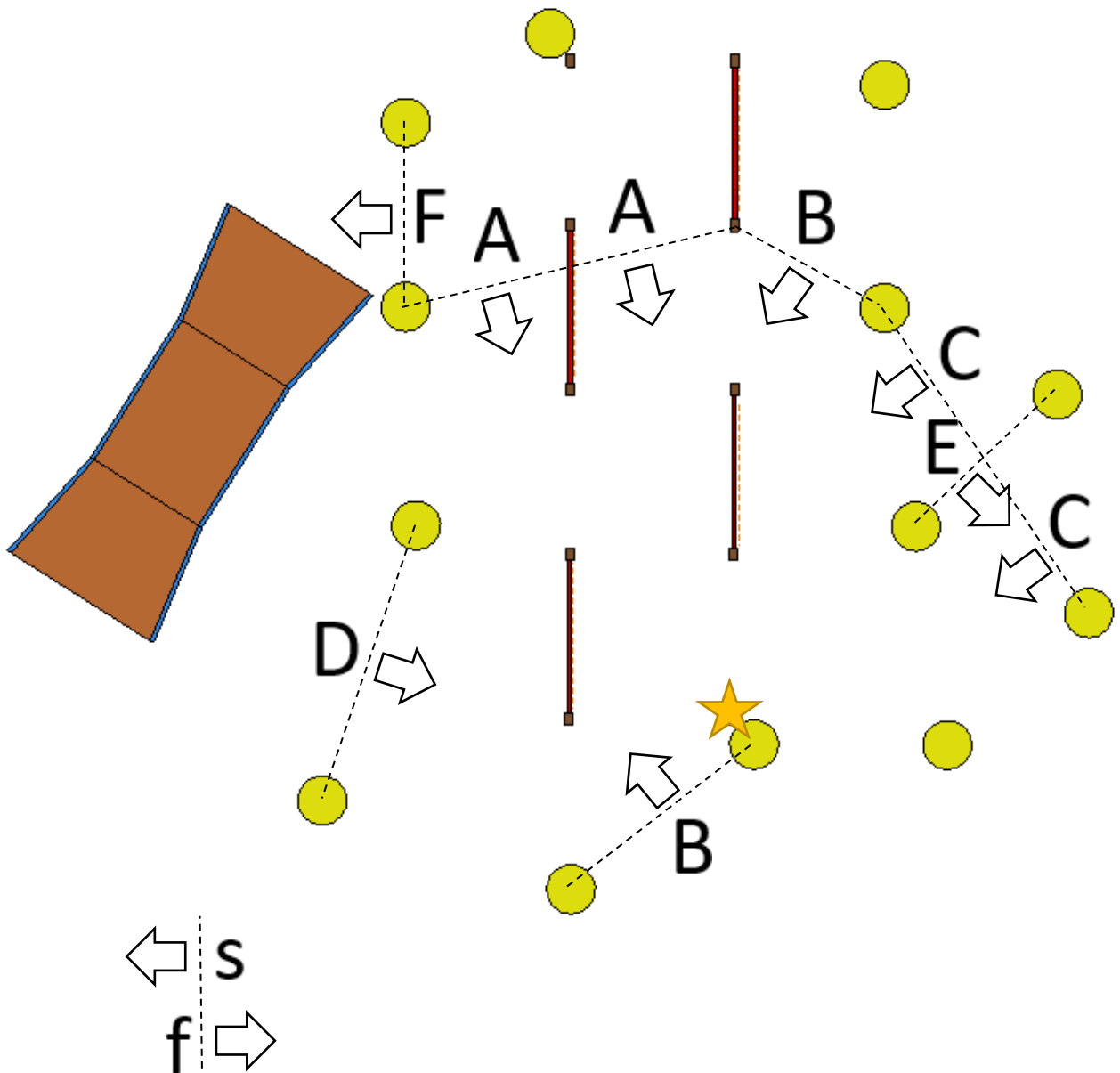

Obstacle 5 les pneus

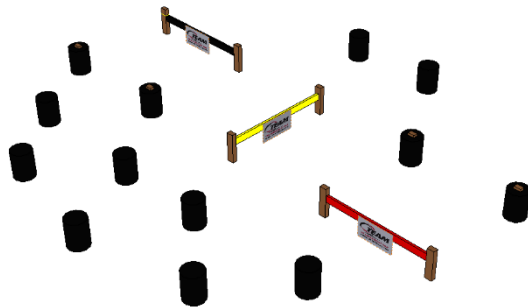

★ 6 X knock down

CAN*** A>F

CAN* A>E

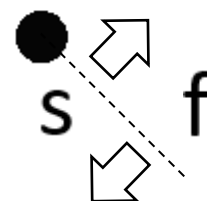
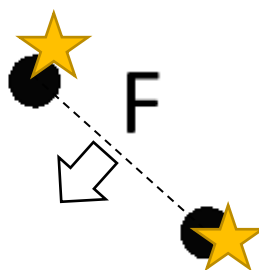
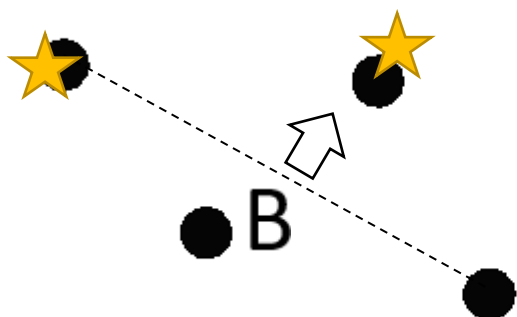
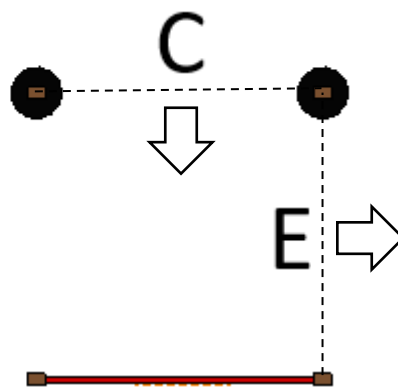
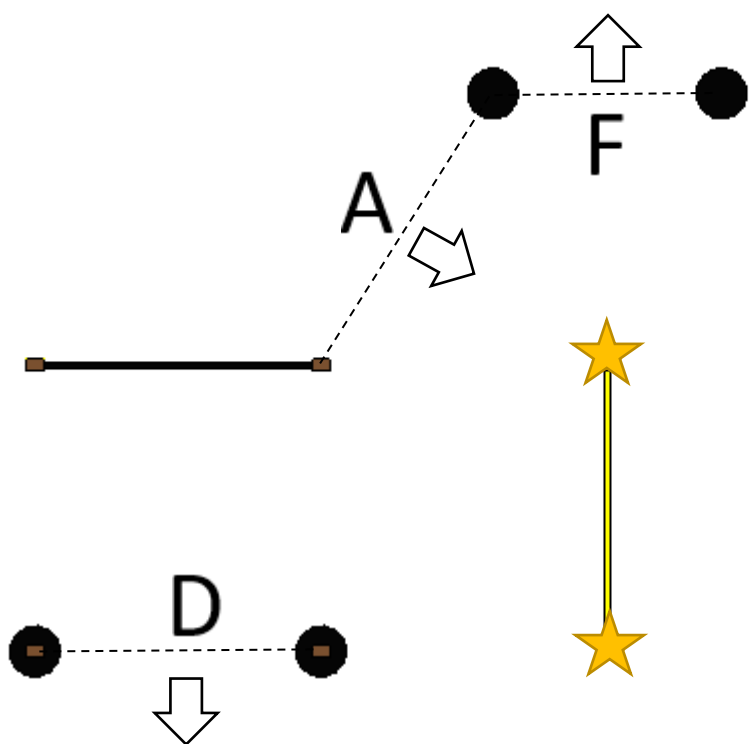

Obstacle 6 les tonnes

KEOLIS

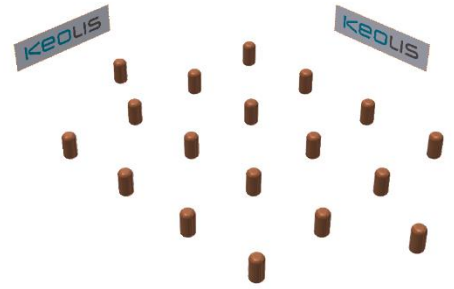

★ 3 X knock down

CAN*** A>F

CAN* XXX
(passer)

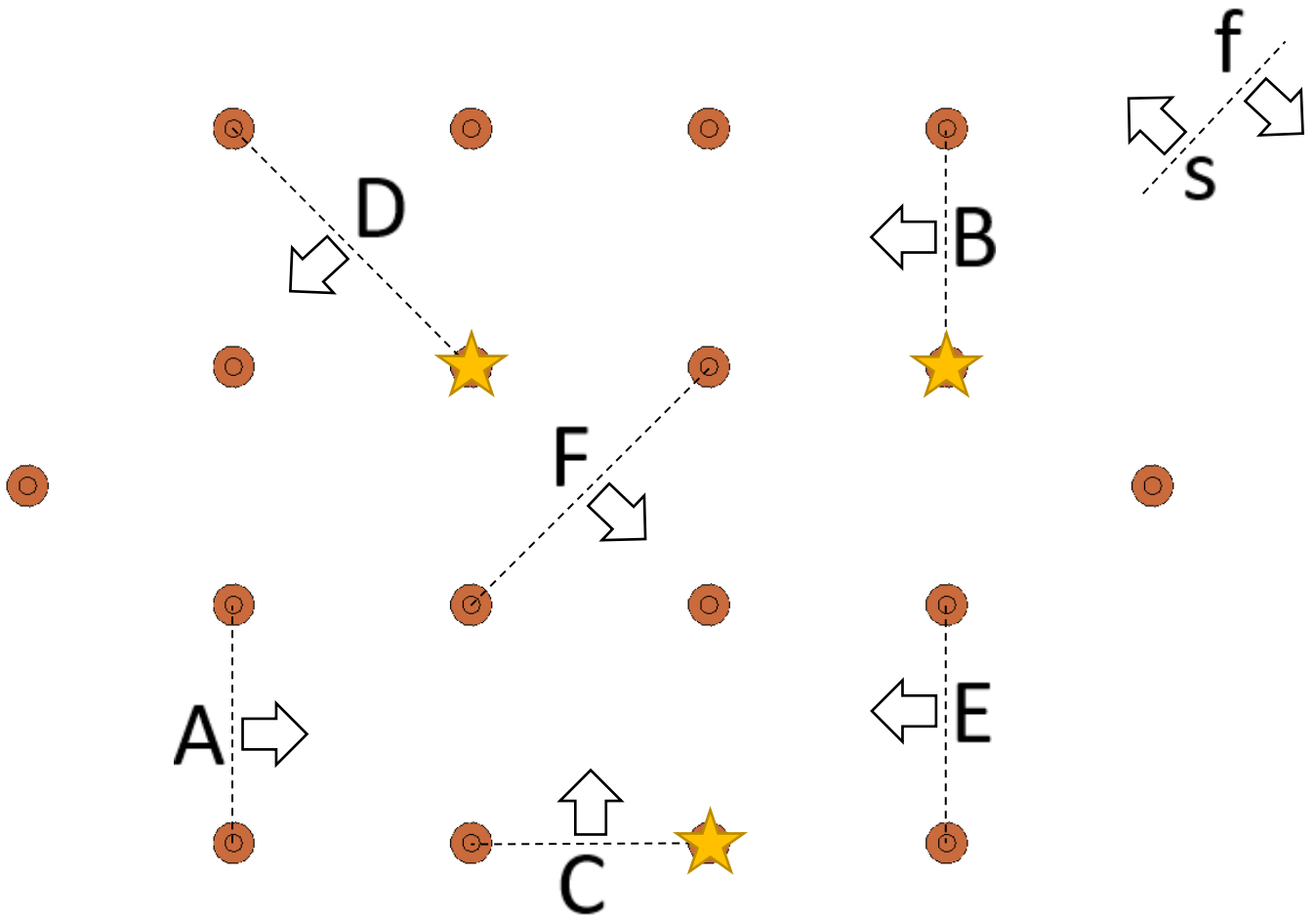

Obstacle 7 les triangles

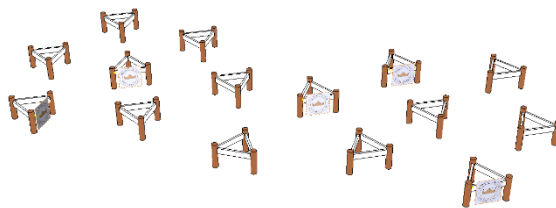

★ 2 X knock down

CAN*** A>F

CAN* A>E

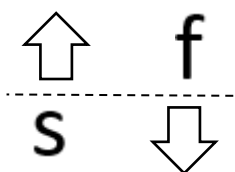
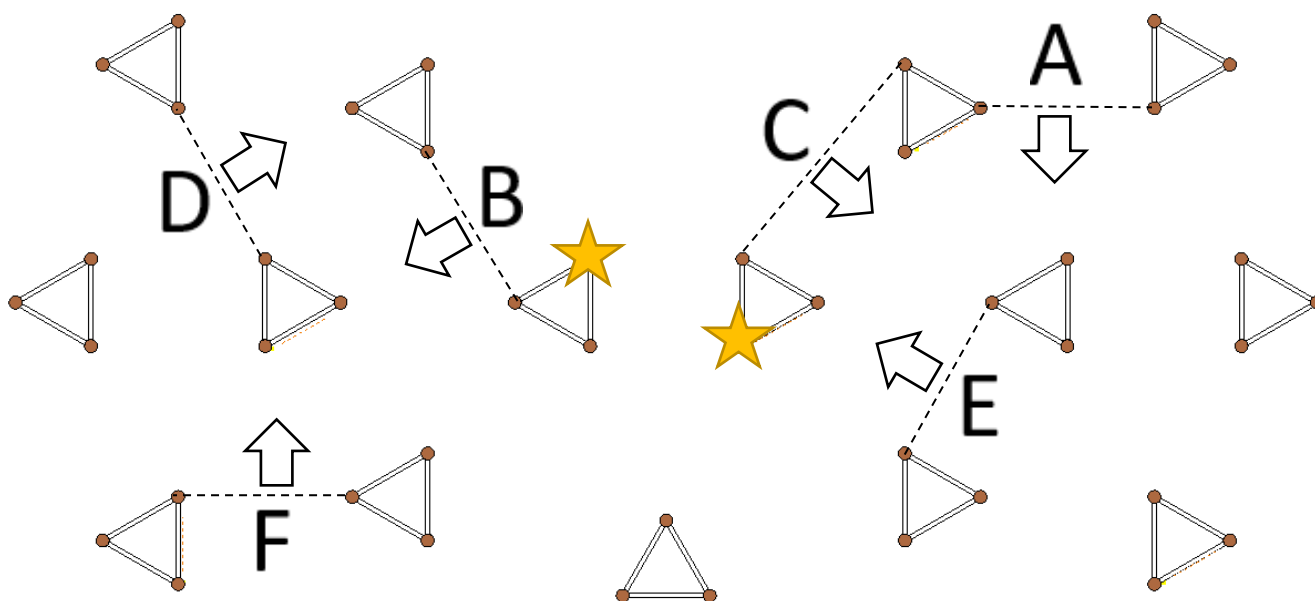

Marathon phase A CAN*** & CAN*



Marathon phase B CAN***(Obst 1>7) (po 1>18)

CAN* (Obst 2,3,4,5,7) (po 1>18) (obst 1,6 passer)

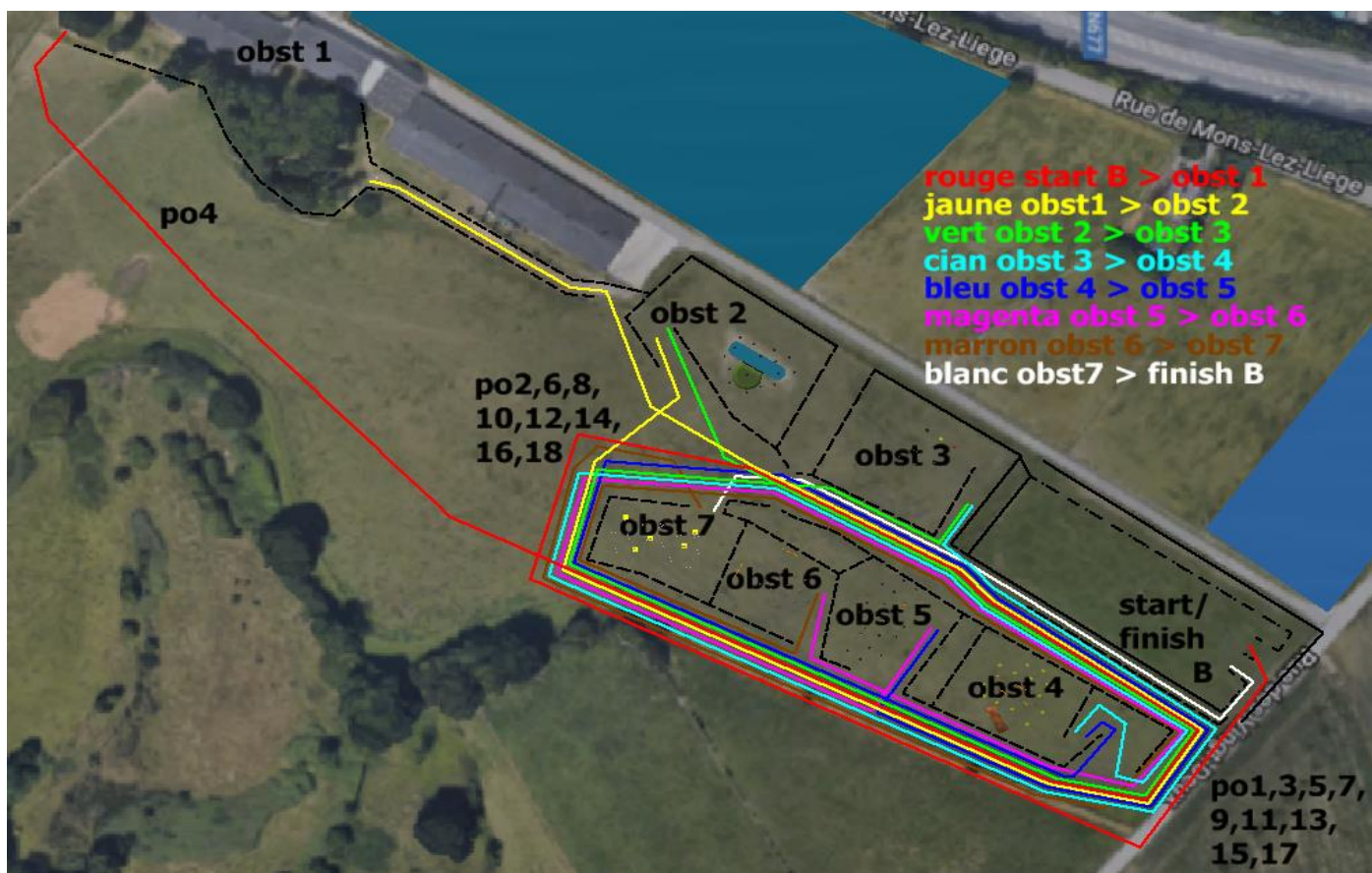

Dimanche 30 septembre maniabilité

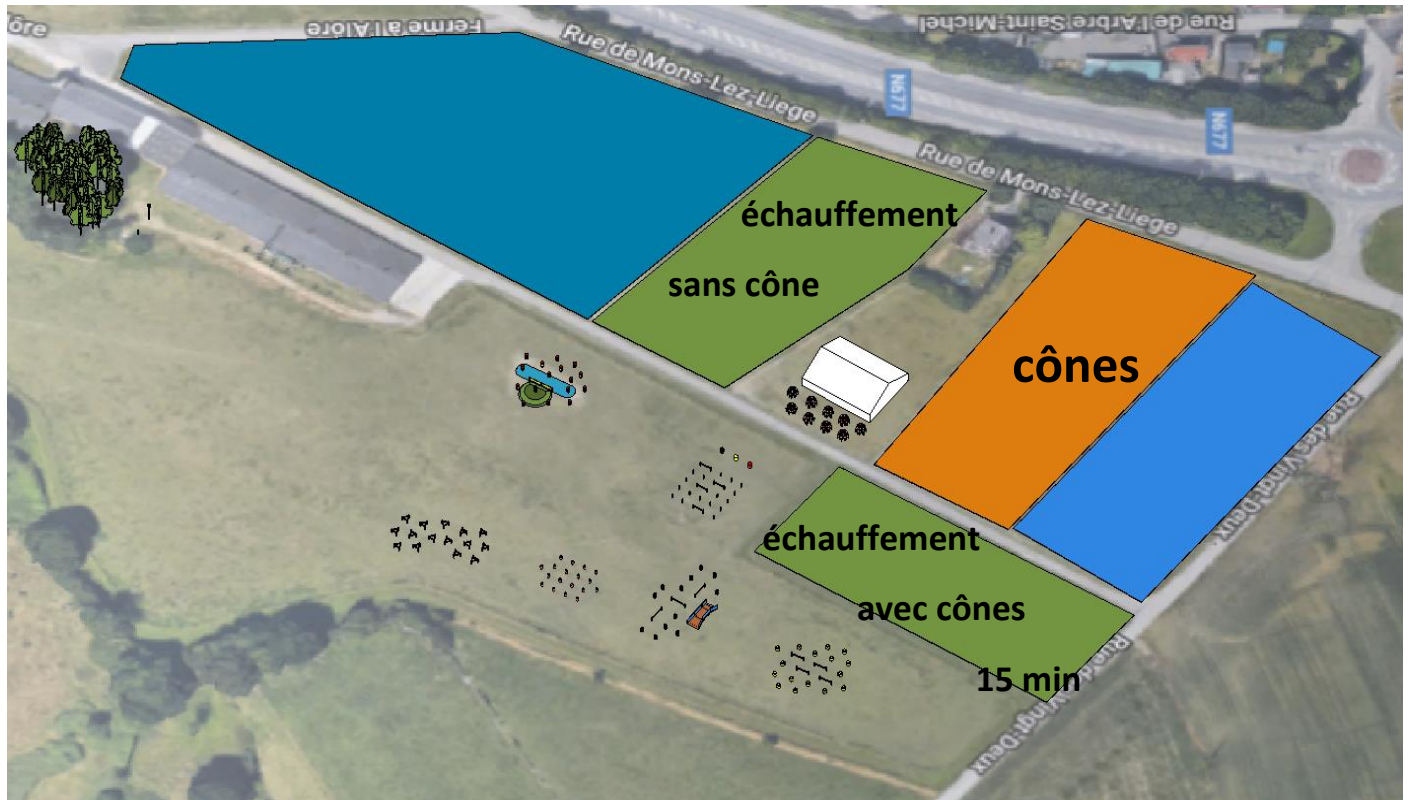

CAN*** 1>20

1	oxer	2m
5 & 7	-5cm	
9	oxer	3m
10abcd	1po,2po	9m
10abcd	1ch,4po	10m
10abcd	2ch,4ch	11m
11abc	1po,2po	7m
11abc	1ch,2ch,4po	8m
11abc	4ch	10m
15abcd	1po,2po,4po	11m,10m,9m
15abcd	1ch,2ch	12m,11m,10m
15abcd	4ch	13m,12m,11m
17	alternative	
19	alternative	
20	oxer	2,5m, -5cm

CAN* 1,2,3,4,5,6,7,8,9,10abcd,11abc,

~~12~~, ~~13*~~, ~~14~~, ~~15abcd~~, ~~16~~, ~~17~~, ~~18~~, ~~19~~, ~~20~~

5 & 7	-5cm	
9	oxer	3m
10abcd	1po,2po	9m
10abcd	1ch,4po	10m
10abcd	2ch,4ch	11m
11abc	1po,2po	7m
11abc	1ch,2ch,4po	8m
11abc	4po	10m
15abc	1po,2po,4po	11m,10m
15abc	1ch,2ch	12m,11m
15abc	4ch	13m,12m
17	alternative	
19	alternative	
20	-5cm	

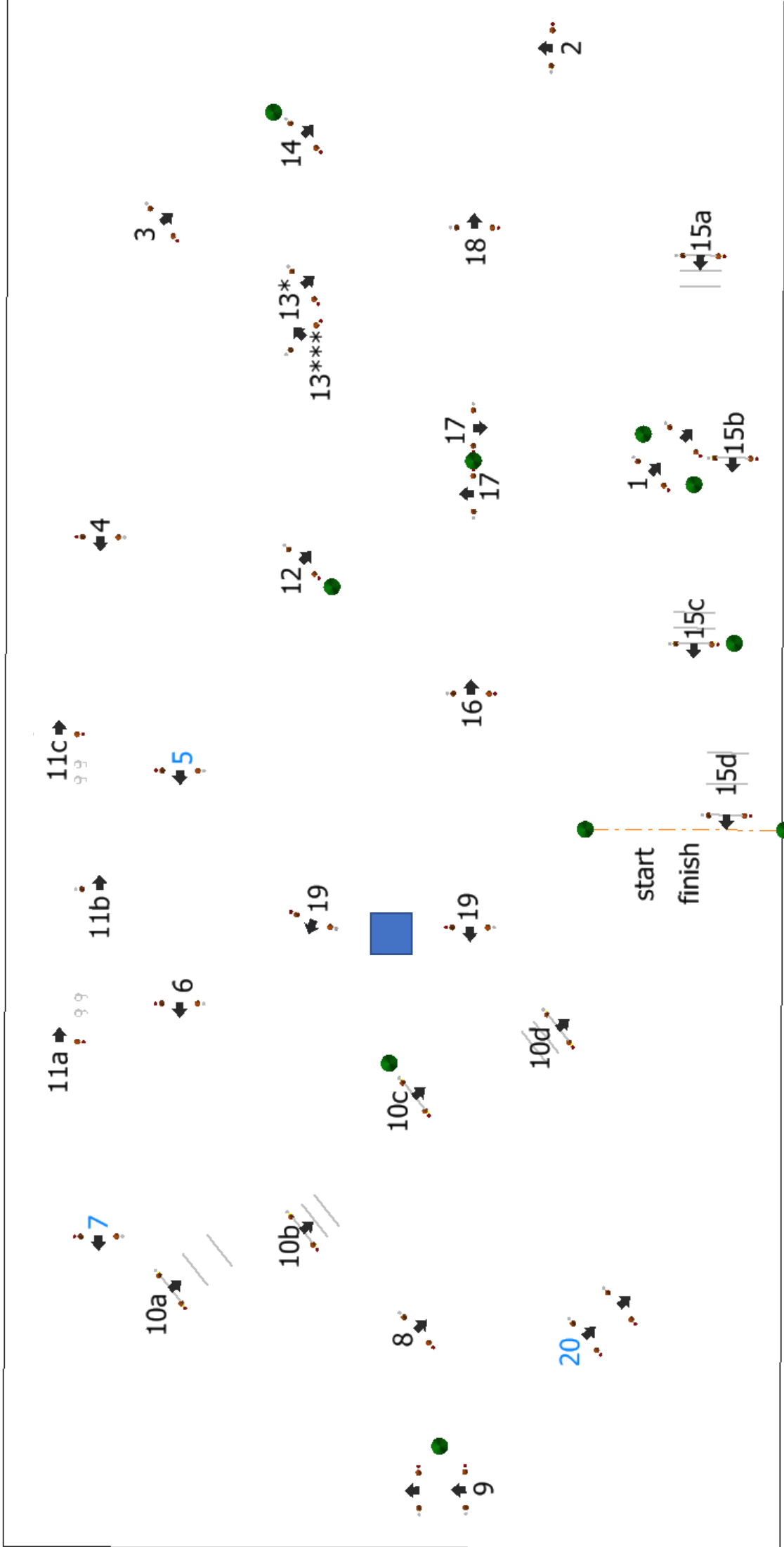

Province de Liège



WILLY GROUP
WILLY NAESSENS
 Industriebouw | Agro | Zwembaden



TEAM
 VP LAMBRECHT VDK
 Q TEAM. LES EXPERTS DU PNEU

KEOLIS

