

Terrein Booischot 2018

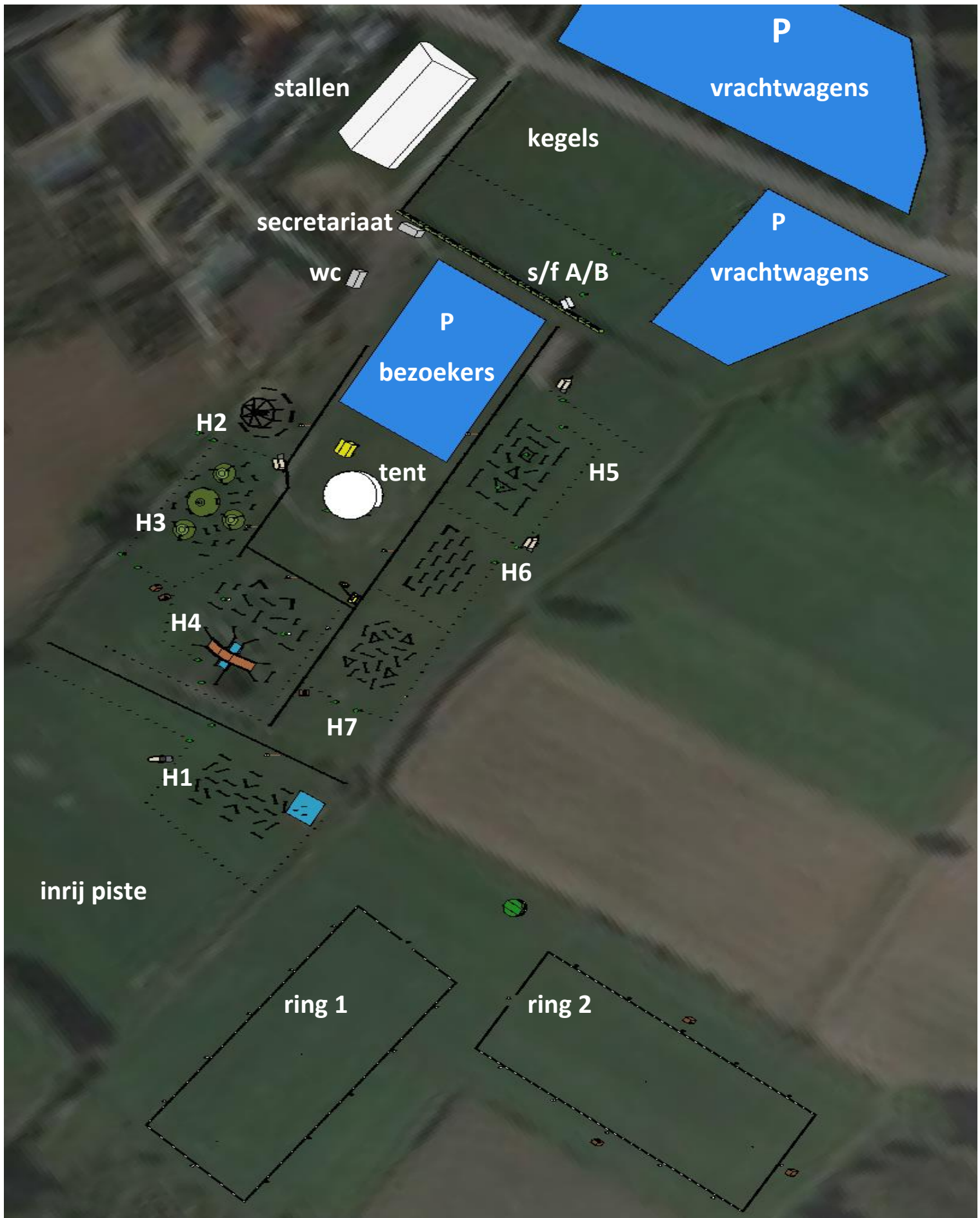

Vaardigheid Booischot 2018

CAN** (elite) 1 > 20

CAN* (amateur) 1 > 20

CAV 1,2,3,4,5,6,7,8,9,10,
11*,12*,13,14,15,20

4abcd > 1po,2po = 9m,9m,9m

> 1pa,2pa,4po = 10m,10m,10m

> 4pa = 11m,11m,11m

17abcd > 1po,2po = 9m,10m,11m

> 1pa,2pa,4po = 10m,10m,11m

> 4pa = 11m,11m,11m

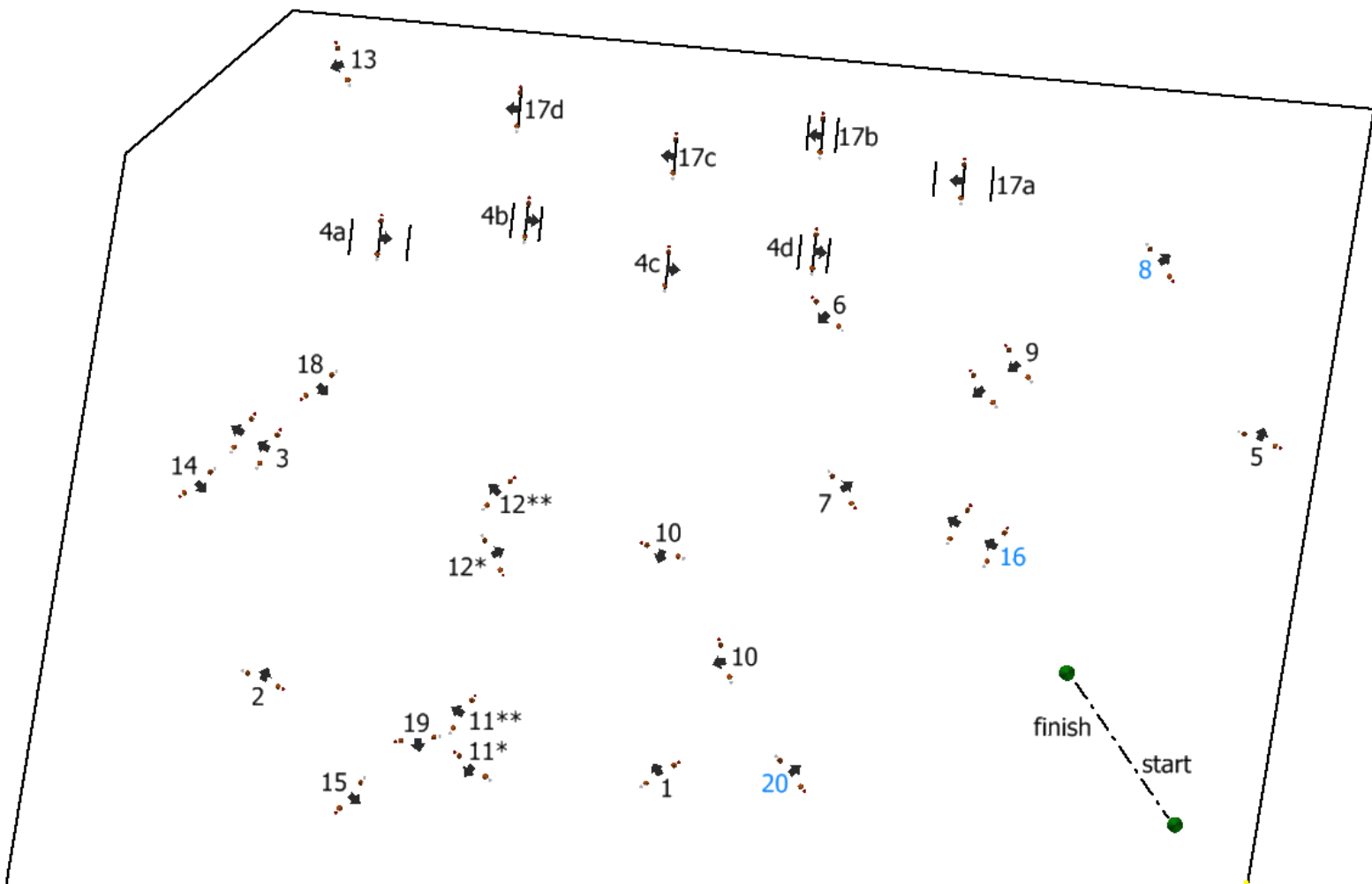



CAN Booschot 2018

Hindernis 1

CAN** A > F

CAN* A > E

CAV A > E

Jong A > E

3 x Knock Down ★

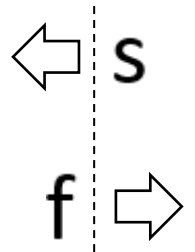
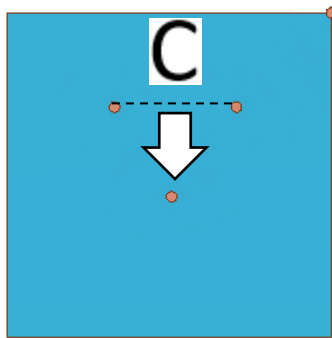
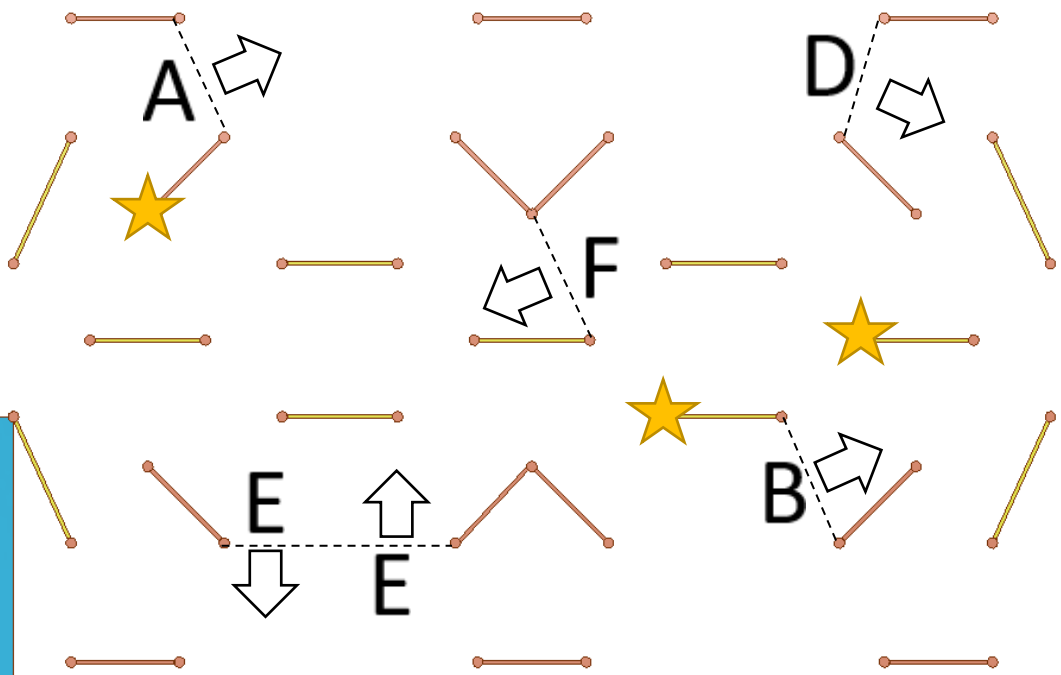
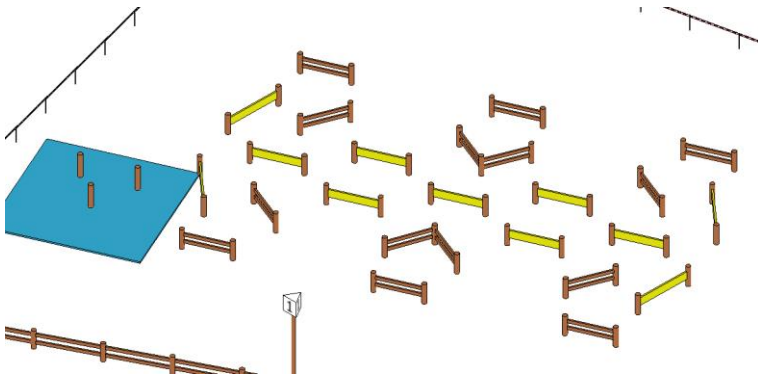



CAN Booschot 2018

CAN** A > F



Hindernis 2

CAN* A > E

CAV A > E

Jong A > E

1 x Knock Down ★

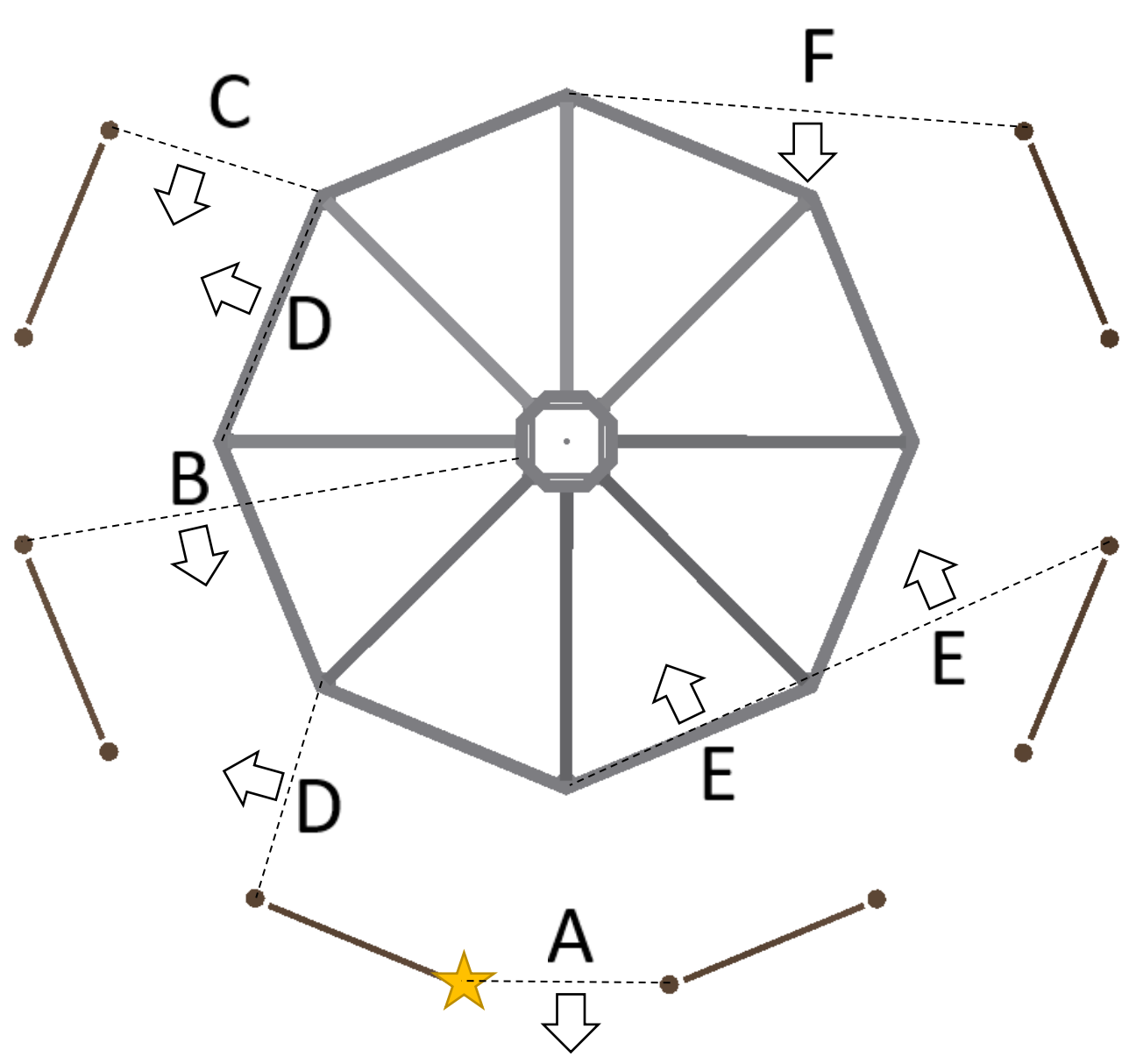
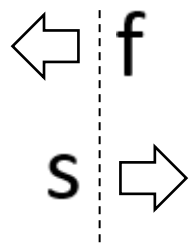
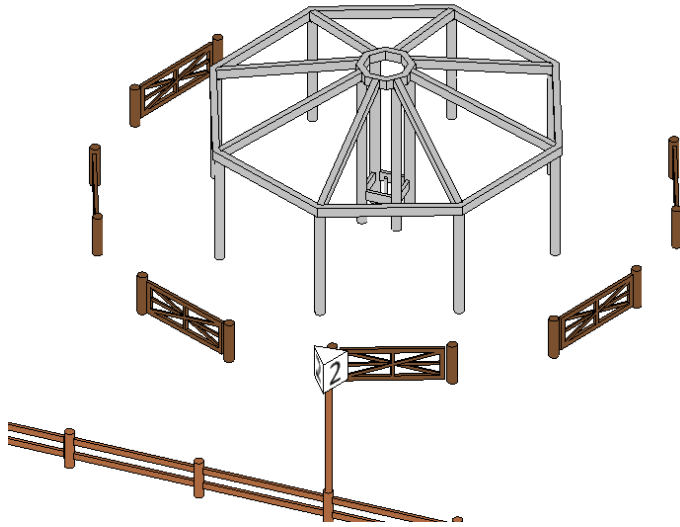



CAN Booschot 2018

Hindernis 3

CAN** A > F

CAN* A > E

CAV A > E

Jong A > E

0 x Knock Down ★

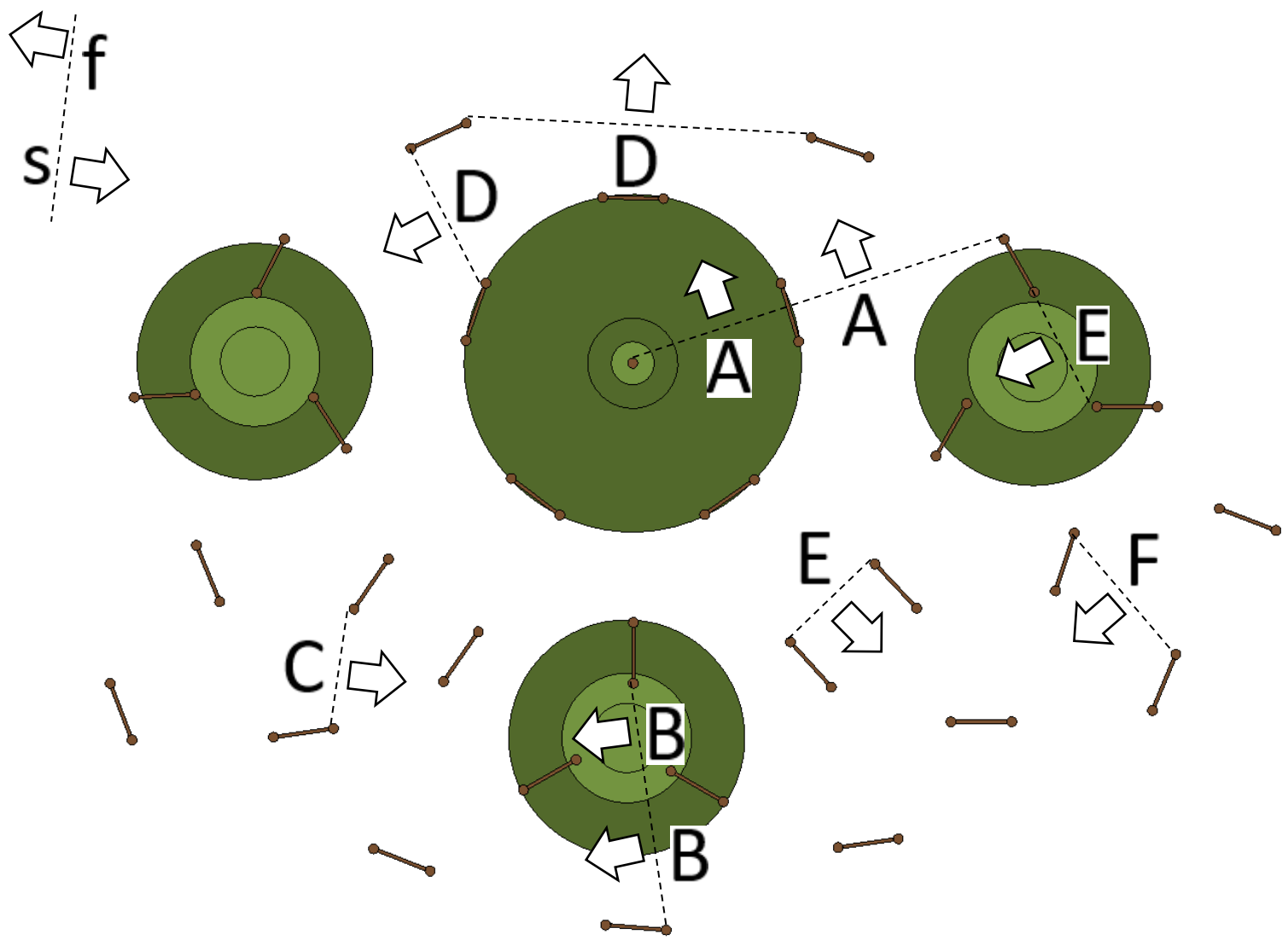
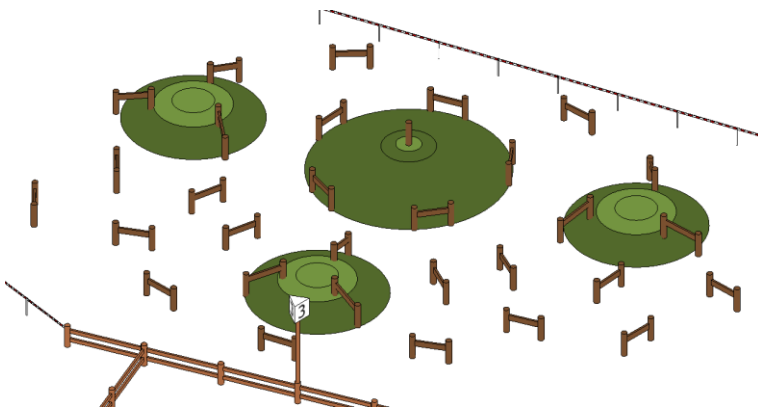



CAN Booschot 2018

CAN** A > F



Hindernis 4

CAN* A > E

CAV A > E

Jong A > E

2 x Knock Down ★

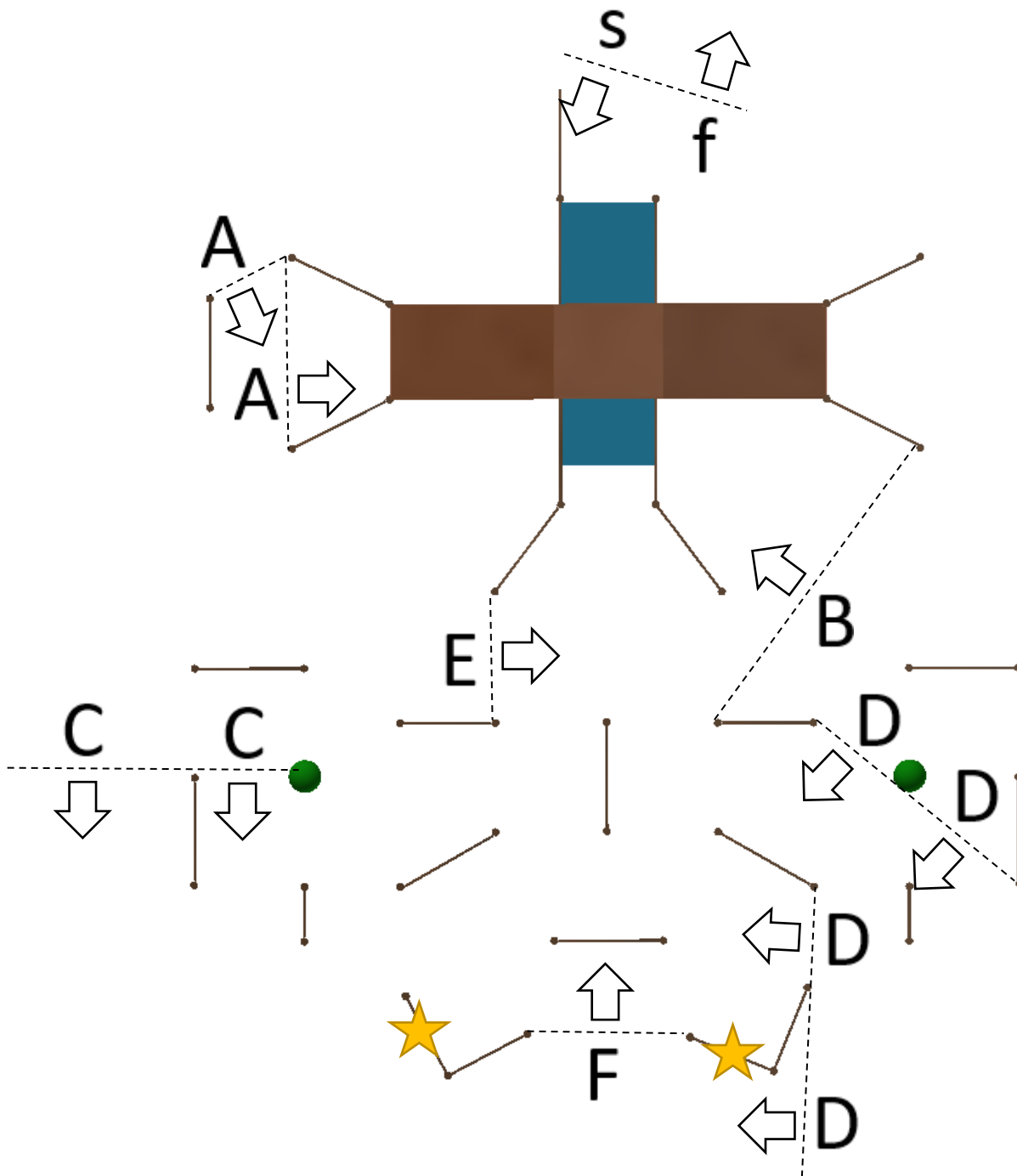
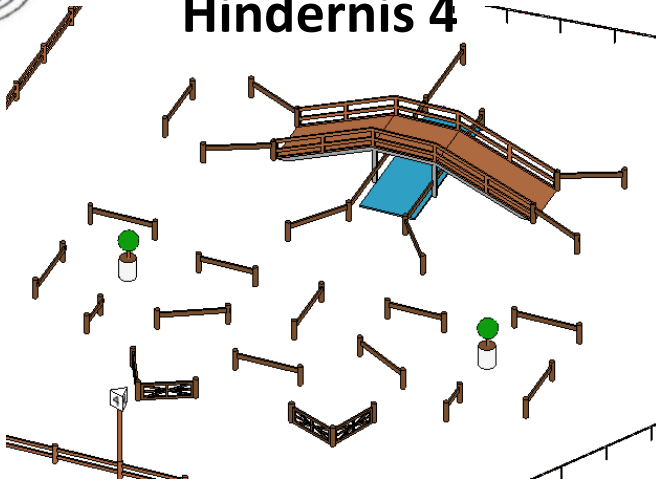



CAN Booschot 2018

Hindernis 5

CAN** A > F

CAN* XXXX

CAV XXXX

Jong XXXX

4 x Knock Down ★

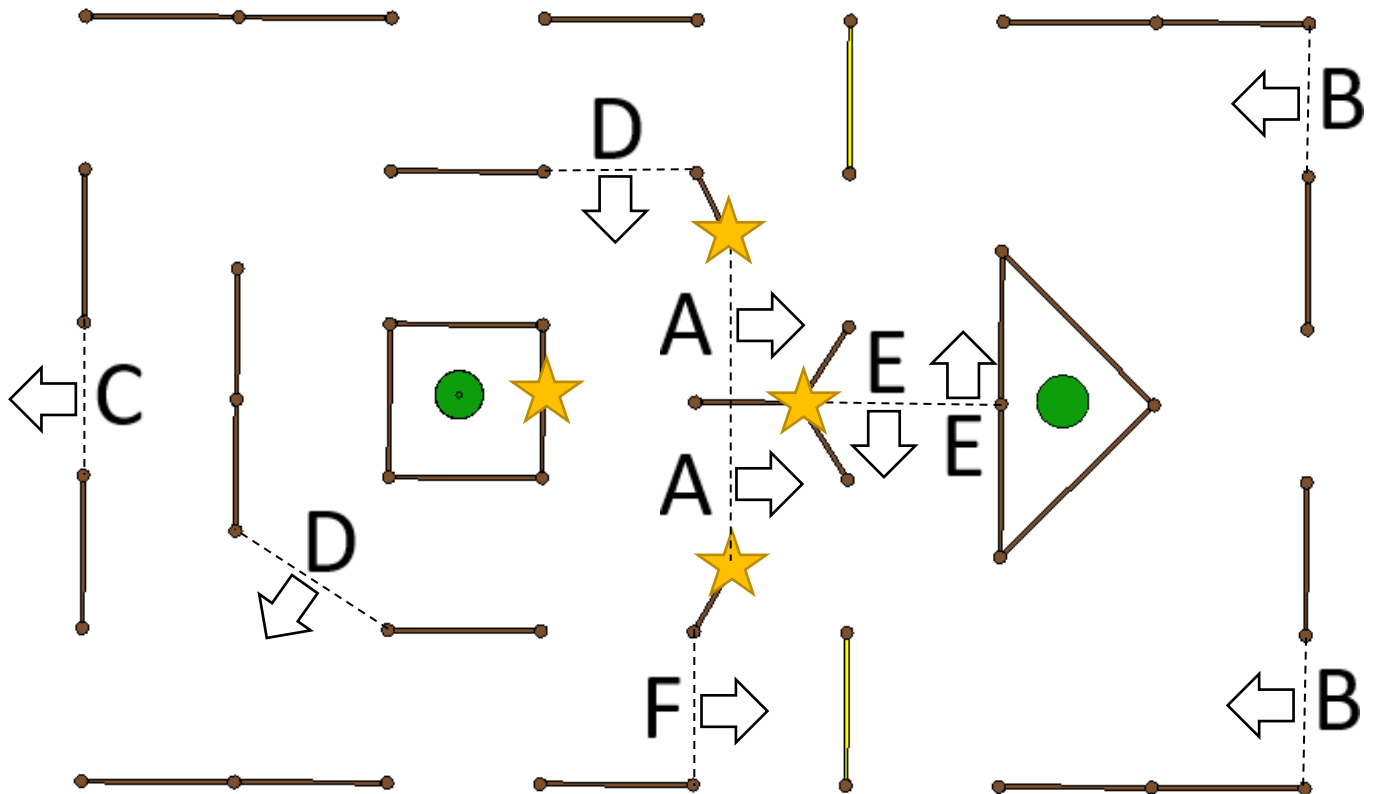
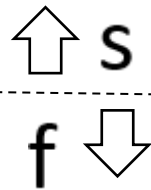
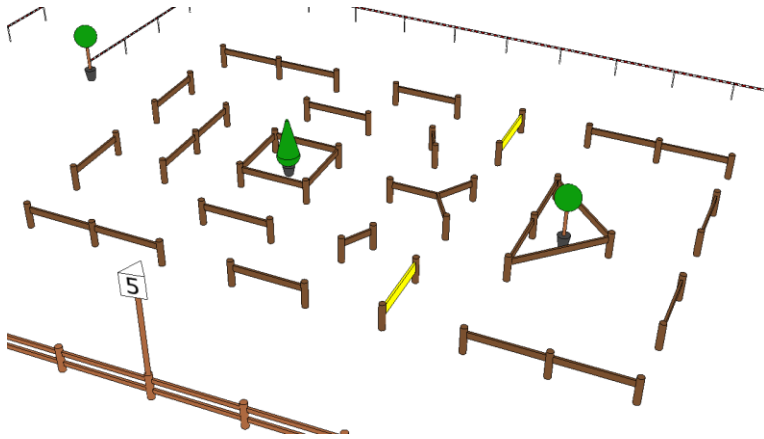



CAN Booschot 2018

Hindernis 6

CAN** A > F

CAN* XXXX

CAV XXXX

Jong XXXX

4 x Knock Down ★

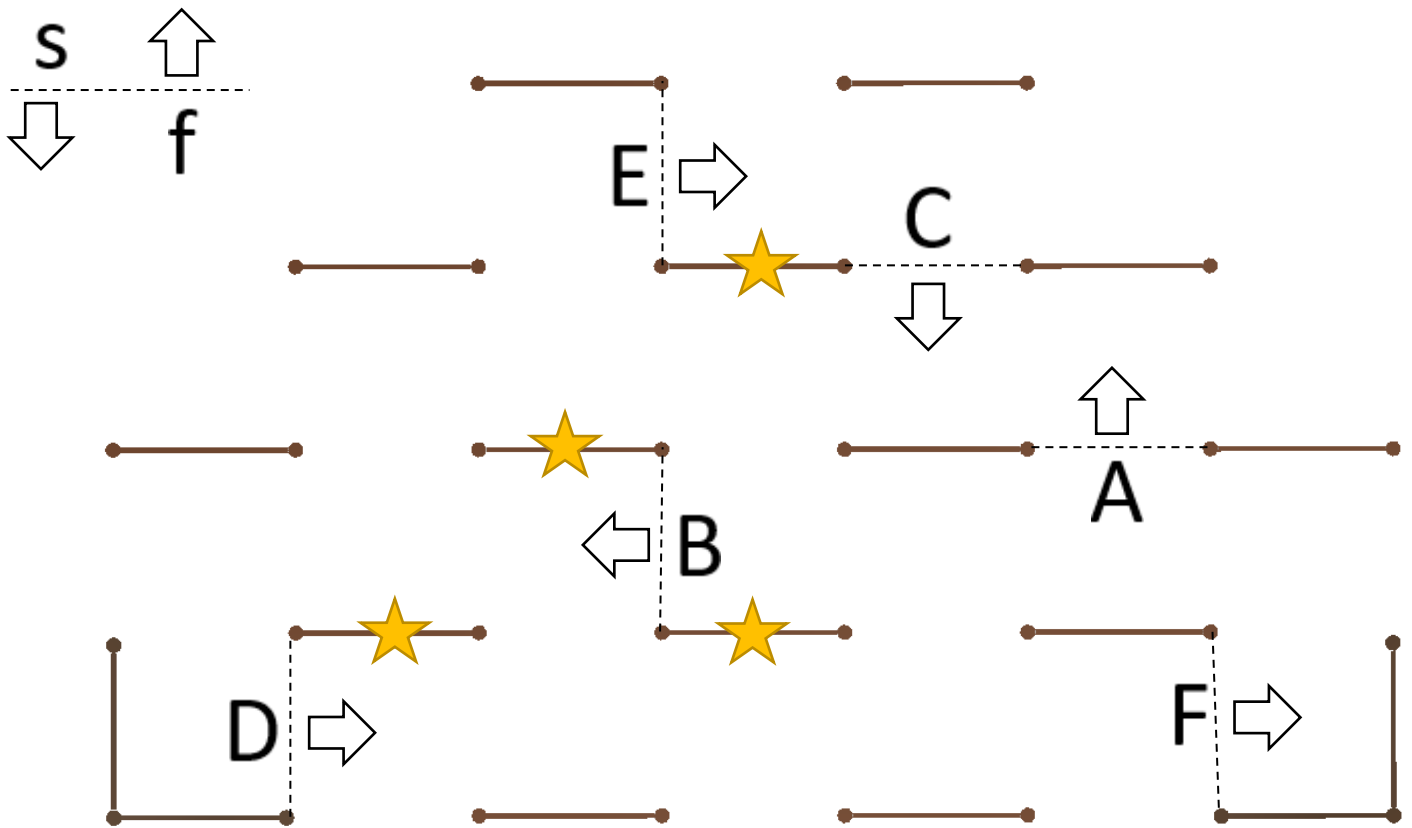
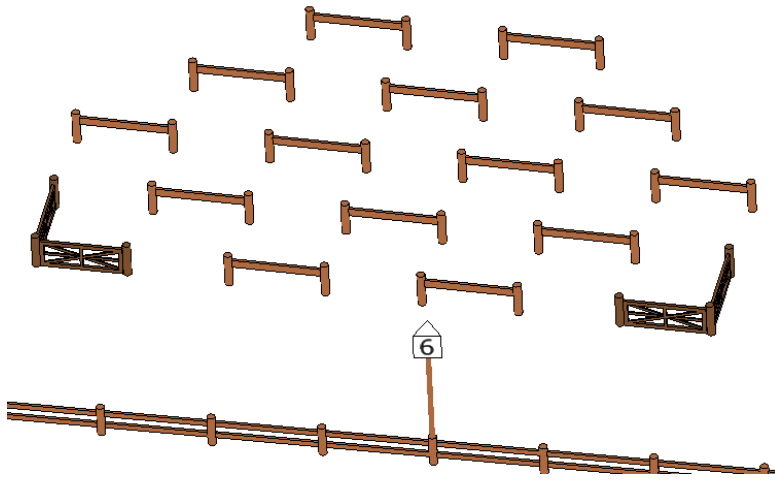



CAN Booischtot 2018

Hindernis 7

CAN** A > F

CAN* A > E

CAV XXXX

Jong A > E

6 x Knock Down ★

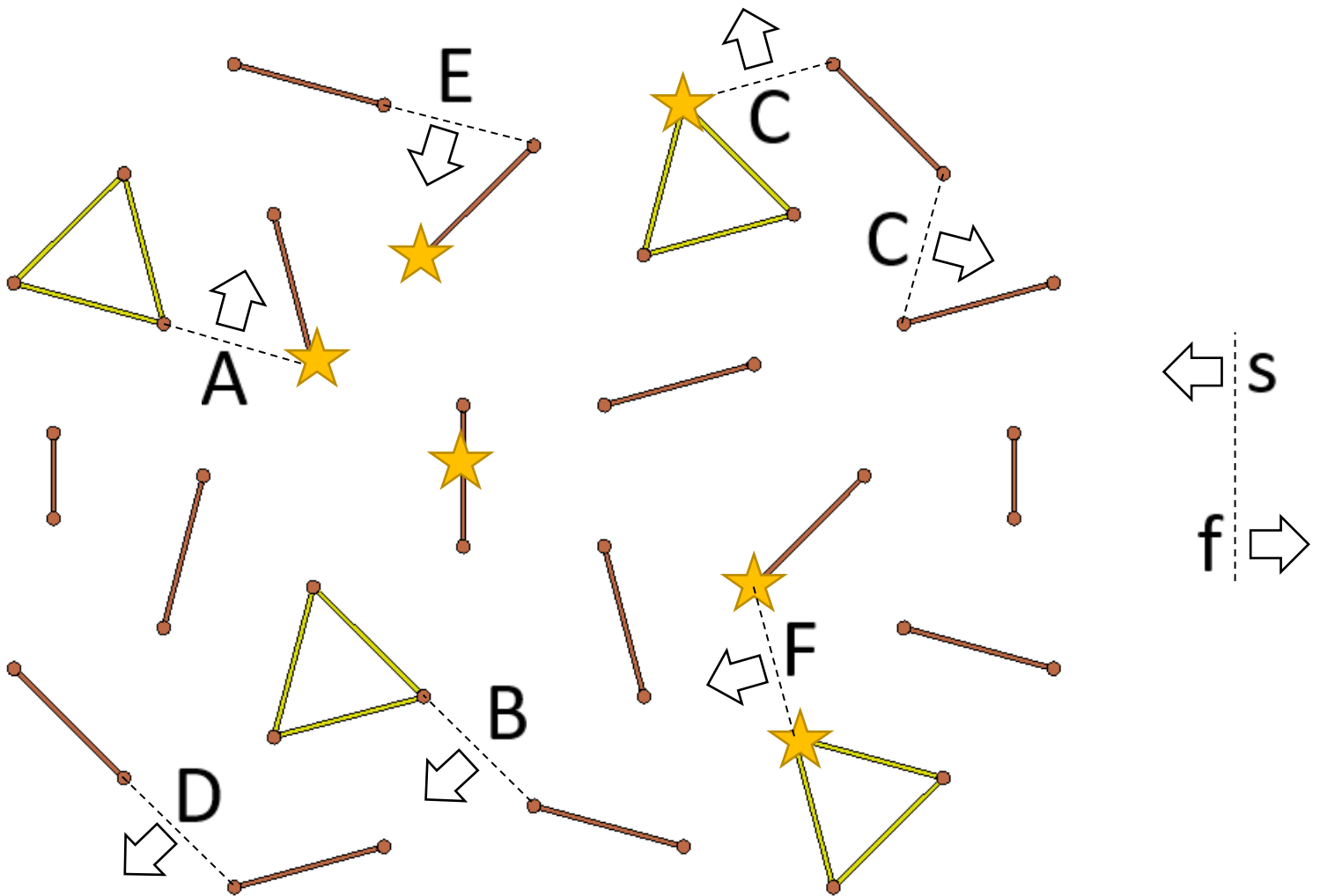
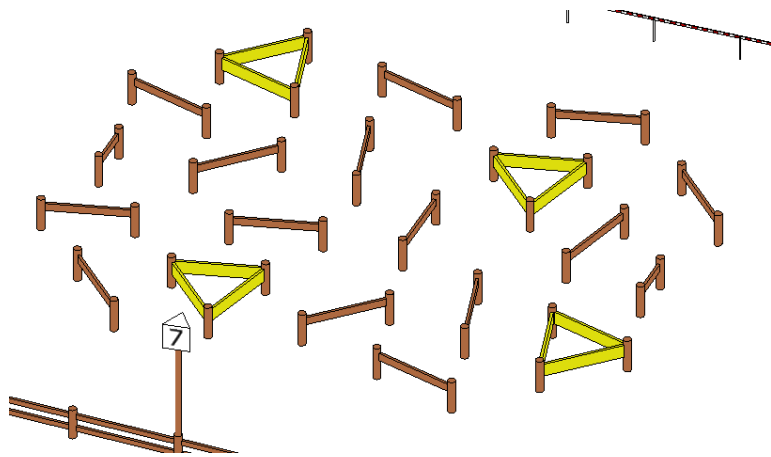



Trajecten CAN Booischoot 2018

start A, km1, po1, km2, po2, po3, po4, km3, 300m, finish A = 3350m

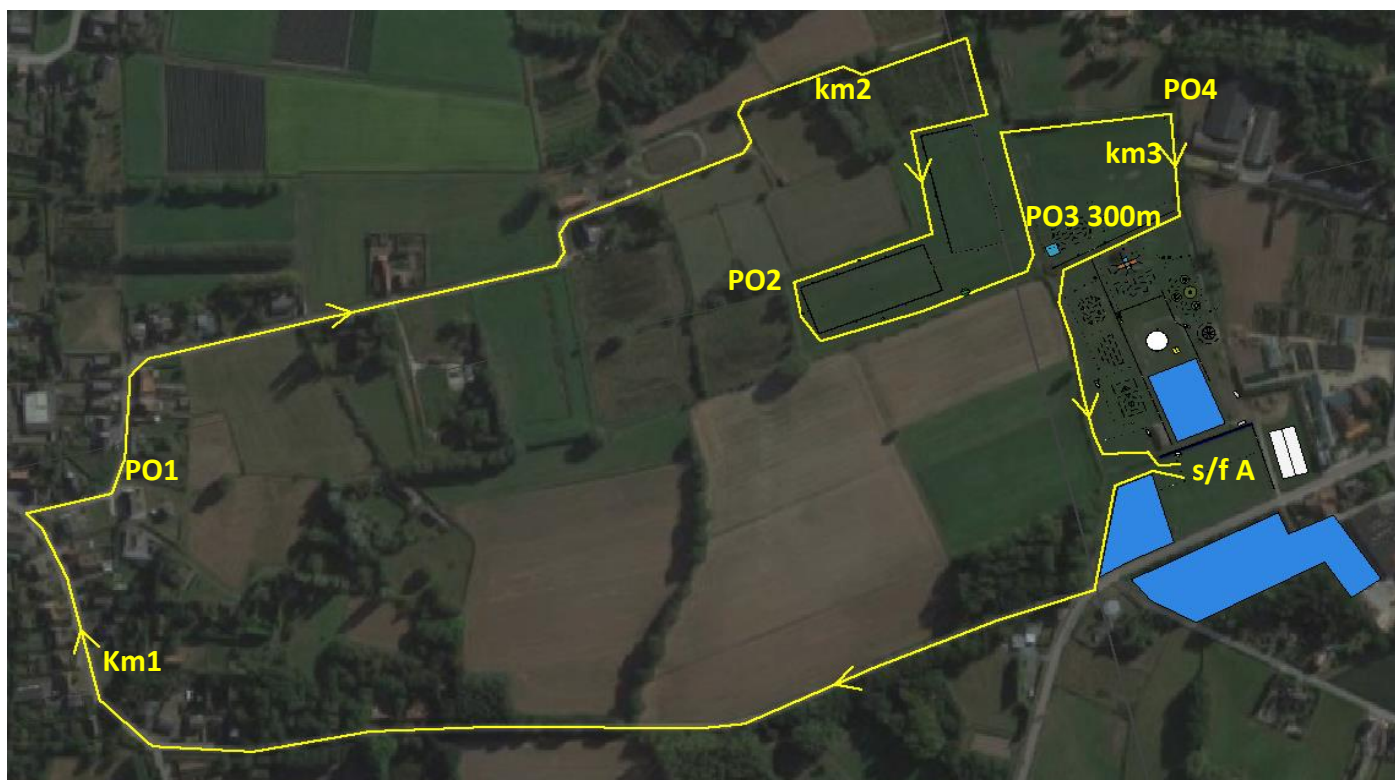

CAN**: start B, po1, H1, km1, po2, H2, km2, po3, H3, po4, km3, H4, po5, km4, H5, po6, H6, km5, po7, H7, km6, finish B = 6100m

CAN*: start B, po1, H1, km1, po2, H2, km2, po3, H3, po4, km3, H4, po5, H7, km4*, finish B = 4320m

CAV : start B, po1, H1, km1 po2, H2, km2, po3, H3, po4, km3, H7, CAV300m, finish B = 3645m

